

User Manual

Home SPA Instrument

MS-54D1S

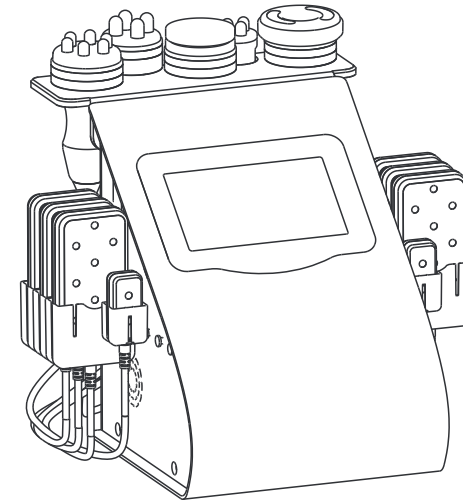

Thank you for purchasing our product.

- Please read this User's Manual carefully for information on how to use the device properly and safely.
- After reading the contents hereof, be sure to keep this User's Manual in an accessible location.
- Make sure to include this User's Manual if you are transferring ownership of the device to another person.

Table of contents

Safety precautions	1
Patients with the following symptoms should be cautious about using this instrument ...	2
Introduction	2
Working Interface	3
Technical parameters	5
Precautions for use	6
Machine cleaning and maintenance	7
FAQs	7
Problems and solutions	10
Operational guidance	12
After-sales guarantee and support	15

Safety Precautions

1. Please read this manual carefully before use so you are familiar with the use of this instrument and related technology.
2. The beauty instrument is a high-precision electronic instrument, so it needs to be stored properly. Do not store it in a place that is damp, exposed to direct sunlight, or around inflammable and explosive materials to prevent damage.
3. Always use the designated accessories provided or recommended by the original manufacturer to ensure the performance of the instrument within normal service life.
4. Do not place the instrument near strong heat, as this may affect its service life and performance.
5. Please refrain from using the device on the eyes, thyroid, parathyroid, testicles, the abdomen of pregnant women, and pacemakers.
6. The instrument is not intended for use by patients unless they have the permission of a doctor.
7. During the operation, the operating part should stay moist, and avoid operation on dry skin.
8. Please turn off the power of the instrument when not in use, and make sure to turn off the general power of the instrument before leaving after daily use to ensure the safety of the instrument.
9. If you are taking other weight-loss drugs, it is recommended to stop the drug for 1-2 months before using the instrument, otherwise the course of treatment needs to be extended.
10. Clean the instrument with a wet wipe after operation to ensure cleanliness and hygiene, and prolong its service life.

Patients with the following symptoms should be cautious about using this instrument.

Please consult a doctor or a professional before using the instrument. The details are as follows:

1. Those who are pregnant or lactating.
2. Those with heart disease or who are equipped with pacemakers.
3. Those whose wounds have not healed and who are recovering from the operation.
4. Those with epilepsy, severe diabetes and hyperthyroidism.
5. Those with a malignant tumor, hemophilia, or severe bleeding.
6. Those with skin diseases and infectious diseases.
7. Use with caution for those who are allergic to electric currents.
8. Those who have a cesarean section within half a year or those who have an abortion within 3 months or natural delivery within 2 months can not use this machine.
9. Do not use around body implants, such as metal, plastic, silicon and so on.

Introduction

This 6 in 1 beauty machine has the most popular and safe body shaping technology to help you complete the transformation of your body. It solves both skin and body management issues for beauty lovers. This equipment requires no injection, no medication, and no operation, thus having no side effects. It is used externally during the whole process and has an immediate effect.



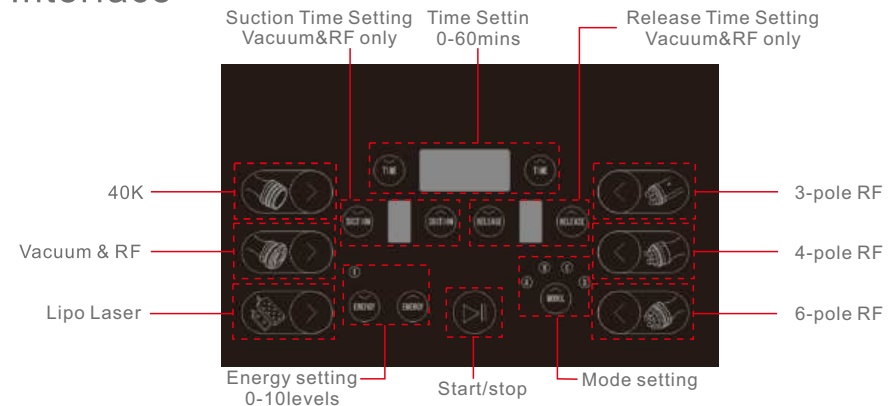

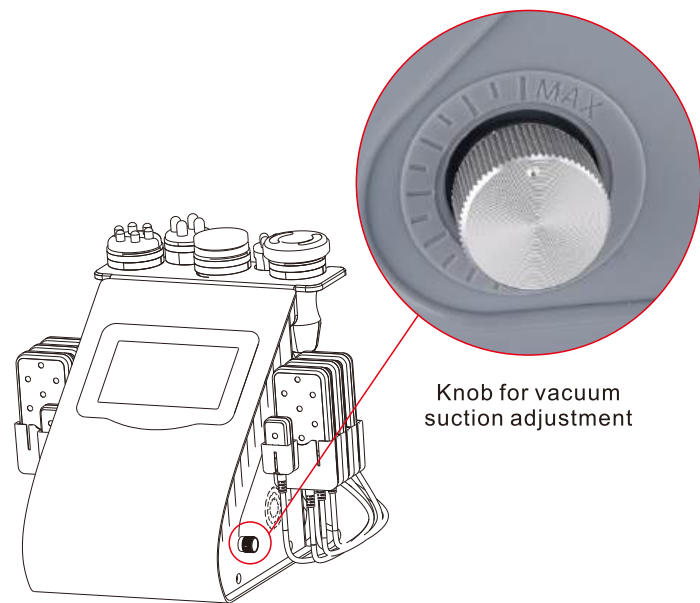

Working Interface



Mode Setting						
A	Continuous working	Continuous working	Infrared light is always on	Infrared light is always on	Infrared light is always on	Infrared light is always on
B	Blink at a slow frequency	Intermittent working	The infrared light turns on when it touches the skin	The infrared light turns on when it touches the skin	The infrared light turns on when it touches the skin	The infrared light turns on when it touches the skin
C	Blink at medium frequency	/	/	/	/	/



Technical parameters

	Power supply Input: AC-110V-220V 50Hz/60Hz		Net Weight: 6.7kg	
	Power: 75W		Gross Weight: 7.8kg	
	Dimensions: 13.6x16.1x15inch(34.5x40.9x38cm)			
	Input Power: 75W			
	Frequency: 40KHZ		Frequency: 1MHZ	Air flow: 6L/min
	Power: 30W		Power: 75W	Noise level: < 60 dB (30cm away)
	Frequency: 1MHZ		Frequency: 1MHZ	
	Power: 67W		Power: 57W	Power: 35W
	Wavelength: 635nm ~ 650nm			
	Power: 5mw			

Precautions for use

1. Use a grounding pin and make sure the power socket of the device is properly connected before each operation.
2. Ensure that the voltage of the instrument is suitable. If the voltage of the local power supply is not stable, we suggest that the user add a voltage regulator with matching power between the mains and the instrument.
3. Before treatment, please remove all metal objects from the body first, so as to avoid unexpected conditions and influence the curative effect.
4. Use device or train device operators in strict accordance with instructions in the user manual.
When taking other weight-loss drugs, it is recommended to stop taking them for 1 to 2 months before treatment. Extension of the course of treatment is recommended if you wish to lose weight immediately.
5. Don't use the instrument with an empty stomach. After a full meal, wait at least 1 hour before a course of weight loss treatment.
6. When operating, the instrument should fully touch the skin to avoid uneven heat.
7. Start from the lowest energy level and slowly add up.
8. 40K handle should not be used on head, chest, breast, heart and back.
9. If the suction is set at too high level accidentally during the treatment, you should stop the treatment immediately and reset the energy level.
10. It is important to install filter cotton when using a negative pressure handle, otherwise the foreign matter inhaled may block the handle.

Machine cleaning and maintenance

1. Be sure to cut off the power supply when not using the machine and store it in a dry, cool, and ventilated area.
2. Removes gel and impurities from the handle surface, wipe the handle surface with a wet towel or 75% alcohol for cleaning and disinfection, then use a dry towel to absorb excess water to keep the handle dry.
3. When cleaning the Vacuum & RF handle, please remove the filter cotton to avoid the growth of bacteria.
4. After cleaning the machine, please cover it with a dust cloth or plastic wrap, and before the next use, please sterilize the handle again.
5. The dust removal inside the machine should be operated by professionals, and it is forbidden to dismantle the machine for cleaning without permission.

FAQs

1. How long can I start seeing results of RF treatment?
A: Normally, you can see the treatment results that day when you take the operation or within one week. Skin collagen tissue is heated and then contracts, and you can obviously feel the sensation of skin being tightened. Because RF works to stimulate subcutaneous tissue to promote collagen regeneration, so the more you take the treatment, the more noticeable the effects will be.
2. Is RF harmful to the skin?
A: No, RF treatment is a non-surgical operation. It stimulates collagen regeneration at the skin's bottom and boosts metabolism, and therefore has no damage to the skin. Local redness and hotness are the normal conditions of accelerated blood circulation, which will be relieved after a moment. So there's no need to worry about that.
3. How long does the body-firming treatment take?
A: One treatment session is 60 minutes. Combining professional technology and instrumentation, remarkable results can be achieved.

4.What functions does this instrument have?

A: It has the functions of dissolving fat and shaping the body, firming & lifting skin and anti-aging. It can be operated on every part of the body. In terms of facial care, it can form face contour, alleviate wrinkles and saggy skin. In terms of body care, it can reduce regional fatness and build an S-shaped curve, and promote metabolism and detoxification of the whole body. Meanwhile, it can also enhance the functions of the viscera and solve sub-health problems.

5.Which one is better in terms of weight loss, liposuction or this machine?

A: The principle of liposuction is to suck out the excess fat in one part of the body through negative pressure suction so as to achieve the purpose of rapid weight loss. It's a surgical treatment requiring anesthesia and so there is the recovery period, which has risks despite its immediate results. However, our instrument is risk-free and without side effects. It can not only help you reduce fat but also stimulate collagen regeneration to lift and tighten skin. It can also build perfect curves by lifting skin, and accentuating women's sexual charm.

6.Will I regain weight after the operation?

A: No, ultrasound works to dissolve fat to reduce weight, and users are not prone to regain their weight. Because what's dissolved through ultrasonic treatment is fat, not water. Fat needs a longer period of time to accumulate, so normally people will not regain the weight.

7.Do I need to be on a diet?

A: You don't need to be on a diet but you need to pay attention to what you eat. Because radio frequency and ultrasonic treatment work to dissolve fat and accelerate metabolism. It's best to avoid eating spicy, oily, or fried food in case they affect regular metabolism. A proper workout for sweating helps with the fat metabolism process. In such a way, the results will be more noticeable.

8.Does RF treatment have side effects on the body?

A: No, RF beauty treatment is non-invasive and is one of the most effective and safest approaches to removing wrinkles and shaping the body. Generally speaking, side effects won't appear. A small number of people may experience transient redness or swelling that will disappear after a few hours. Those with dry skin may experience atrophy after treatment, which will disappear after three days because collagen regeneration will make the skin plump up though RF heat can cause moisture loss in the skin. Overall, there are no side effects on people's health.

9.Can ultrasound treatment be performed on every part of the body?

A: No, ultrasound treatment works to rupture fat cells, by which fat is released from cells and then metabolized through the lymphatic system. So its power is very high. The heart is sensitive to high-frequency sound waves since it is a hollow organ. After being vibrated by sound waves, the heart will reflect the waves due to the different transmission of sound waves by the muscle tissue and the blood in the heart. This force can pull valves away from the heart muscle. If you use the instrument on the eyes, it can lead to retinal detachment, so the ultrasound treatment should not be performed on the areas of the eyes and heart. (not on the areas of waist, back, and chest).

10.Does ultrasound treatment have side effects on the human body?

A: No, ultrasonic beauty treatment is a non-surgical and non-invasive program without anesthesia. It relies on ultrasound (mechanical sound wave) - to dissolve fat through cavitation - ultrasound focusing. And the results are fat smash - fat dissolving - skin firming and body sculpting respectively. It only targets low-density fat cells but leaves high-density tissue like blood vessels intact, and therefore has no side effects on the human body. Slight tinnitus will probably occur during the treatment, which is within normal range. So there's no need to worry about that.

11.Why does tinnitus occur?

A: It's because ultrasound comes with a high-frequency vibration, which could go up to 20kHz. It penetrates into 20mm-deep skin fat layers through ultrasound focusing. Highly intensified ultrasound can cause high-speed friction among fat cells, which can heat and dissolve them. And during the process, sound may be produced so that customer will have the sensation of tinnitus.

12.What is collagen?

A: Collagen is a kind of biological macro molecule substance, a kind of white, opaque, and non-branched fibrous protein. It can supplement the nutrients needed by all layers of the skin, enhance the collagen activity in the skin, retain moisture, nourish skin, slow down aging, relieve facial relaxation, provide nutrients for the hair, and so on. Collagen is a nutrient that the human body must replenish to delay aging. With the growth of age, collagen will gradually be lost. For women, collagen will begin to decrease at the age of 20. At the age of 25, collagen loss will reach its peak. At the age of 40, the collagen content is less than half of that one has at age of 18. It is the loss of collagen and water that causes wrinkles on the face of the elderly. The breakage of collagen fibers and elastic fibers will cause skin tissue to be oxidized, atrophied, and collapsed. The skin will be dry, wrinkled, flabby, and inelastic. Therefore, in order to delay aging, there must be plenty of collagen.

13.How vacuum therapy works?

A: Vacuum can cause capillary congestion, and stimulate cells to increase vitality. The suction and release of pressure during operation can make local pores continue to open and close, which can promote skin breathing, increase the amount of skin

oxygen, and speed up waste removal. So it achieves the effects of promoting qi and blood circulation, dispelling cold and dampness, dredging meridians and collaterals, clearing toxins, dissipating heat, and so on.

14. Will there be a rebound through laser fat-dissolving?

A: Normally not. The number of adipose cells in the body is fixed, which will not see a change in adulthood. The increase in weight is due to the increase in the volume of adipose cells. Laser fat-dissolving treatment will destroy the localized fat structure, and then reduce the volume of fat. Admittedly, the rare occurrence of regaining weight does not mean that it will not be seen again. In general, as long as one's diet is reasonable and binge eating is avoided, he will not experience weight gain.

Problems and solutions

Problem	Caused Reason	Solution
1. The machine cannot be started?	The power cord connection is unstable	Please check the power cord whether is correctly connected to the socket with a normal power supply.
	Fuse loose or burnt out	Please replace the fuse on the back of the instrument and restart the machine
2. The machine stop working and cannot be restarted	Voltage instability or long-term working caused fuse burnt out	Please replace the fuse, wait for 5 minutes and restart the machine
3. The machine can be turned on, but the screen shows an erroneous message	Data loading error	1. Please turn off this machine, unplug the power cord, wait for one minute to connect the power supply and restart the machine 2. If the above method cannot solve the problem, please contact the instrument dealer to replace the machine

Problem	Caused Reason	Solution
4. No RF output of the machine	The handle is connected incorrectly	Please check whether the plug connecting the handle and the machine body is tightly connected.
	The treatment area is not cleaned (Grease or essential oils products may cause the handle to contact the human body poorly)	Please clean the treatment therapy area and apply gel.
	The RF handle didn't connect the human body tightly	Please make sure that each polar of the RF handle is in contact with the skin tightly when using.
5. The machine has no suction or weak suction	The filter is not installed correctly or the accessories aging	1. Please check the filter whether has been installed correctly. Also check the rubber ring on the filter whether is installed correctly or is aged 2. Please check the suction control knob on the side of the machine whether has set the highest level.
	The handle blocked	Please contact the instrument dealer to replace the handle.

Problem	Caused Reason	Solution
6. The 40K handle doesn't work	→ The mute design of the handle makes the user misunderstand that it does not work	→ Please refer to the 40K handle test method to check whether the handle work normally.
	→ Didn't use massage gel or use non-instrument-specified skin care products	→ Please use specialized 40K treatment massage gel.
	→ The massage intensity is soft	→ Please increase massage intensity appropriately.

Operational guidance

Face (Step1:  10mins)



> Step2:  20mins

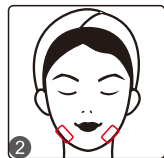

Eye () 10mins



Arm (Step1:  15mins > Step2:  15mins > Step3:  15mins)

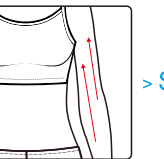
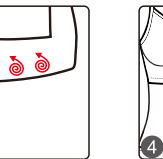
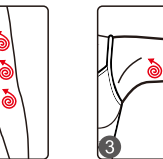
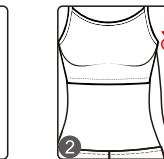
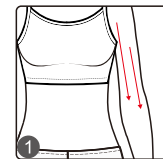

> Step4:  15mins

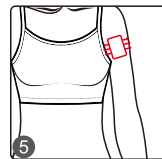

Belly (Step1:  15mins > Step2:  15mins > Step3:  15mins)

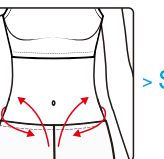
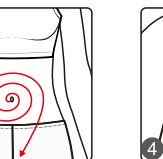
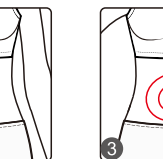
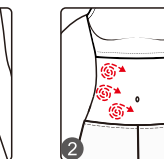
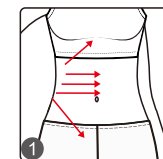

> Step4:  15mins

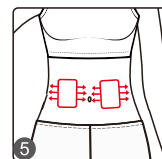

Back (Step1:  15mins > Step2:  15mins)

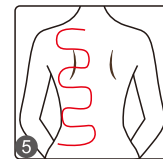
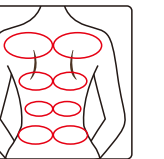
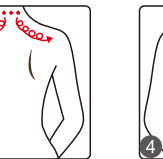
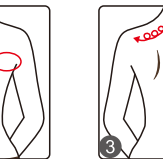
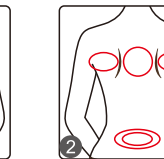
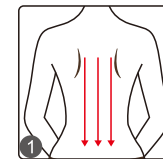

Leg (Step1:  20mins > Step2:  20mins)

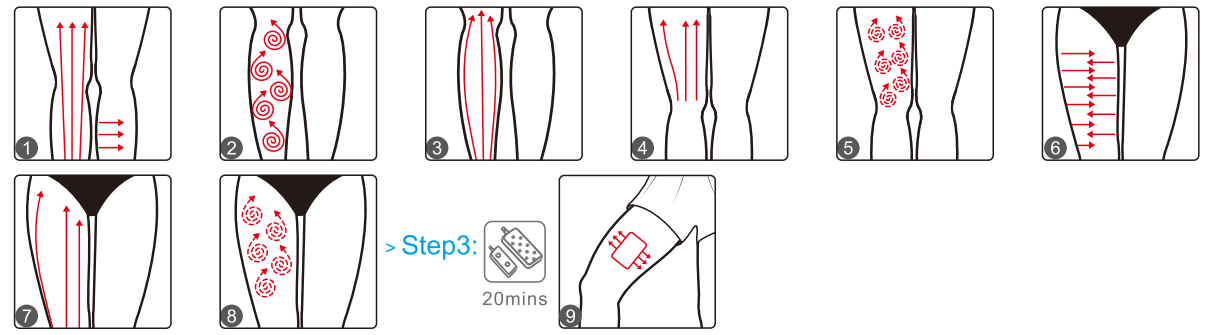

After-sales guarantee and support

We offer a one-year warranty on the main unit and a three-month warranty on components.

Product Name: Home SPA Instrument
 Product Model: MS-54D1S
 Production Date: _____
 Quality Inspection: _____

