

# User Manual

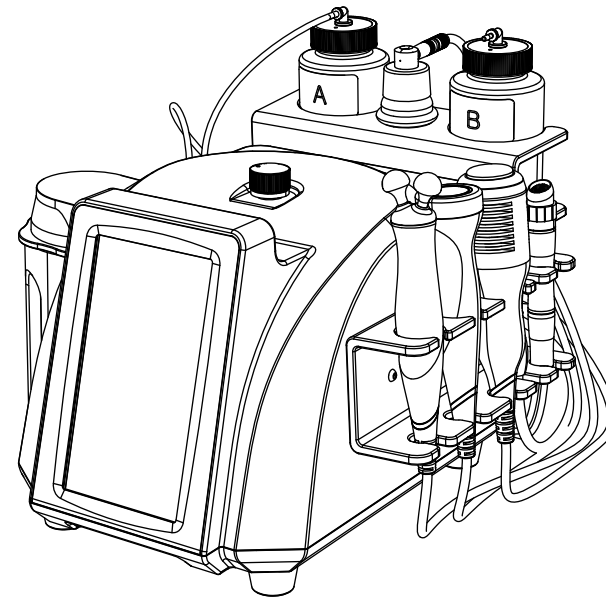

Thank you for choosing the Facial Skincare Device. Please read this user manual carefully before using the instrument!

This device uses Microdermabrasion to grind and suction off the old and dead skin cells to revitalize the skin; Hydro vacuum suction to deeply clean the impurities in the hair follicles; Spray to atomize the moisturizing essence and penetrate the skin base to build a repair barrier; Cold&Hot to gradually expand and close the pores, and soothe and calm; Serum boost handle helps maximize essence penetration and boosts nutrient absorption, Dynamic Pulse Mode uses microcurrent to firm and sculpt facial contours, EL to enhance permeability with electrical pulses, The Skin energy handle employs bio-electrical current to activate cells, revitalize skin and enhance anti-aging results. The entire set of devices forms a skincare closed loop, reviving the health and vitality of the skin from the surface to the inside.

## Content

1.Effect .....	1
2.Use Precautions .....	1
3.Contraindications .....	2
4.Technical Specification .....	2
5.Packing List .....	3
6.Installation .....	5
7.User Guide .....	10
8.Troubleshooting .....	29
9.FAQ .....	30
10.Warranty and support .....	31

## 1.Effect

1. Improve age spots and blackheads
2. Reduce hyperpigmentation (dark patches on the skin)
3. Exfoliate the skin to make it fresh and rejuvenated
4. Improve fine lines and wrinkles
5. Improve large pores
6. Reduce blackheads and whiteheads
7. Improve redness and sensitivity of the skin
8. Improve skin laxity and sagging

## 2.Use Precautions

1. Please read this manual carefully before use to understand the usage method and related technologies of this product.
2. This product is provided with warranty service by the designated after-sales service unit.
3. When using the Hydro and Microdermabrasion functions, start from the lowest suction level and gradually increase the suction level after the skin adapts.
4. This skin management integrated device is a high-precision electronic product. It should be properly stored and kept. Do not place it in damp, direct sunlight or areas with flammable or explosive items to prevent damage.
5. When not using the instrument, turn off the power switch and make sure to turn off the total power of the instrument before leaving to ensure electrical safety.

## 3.Contraindications

Those with the following symptoms should use this instrument with caution. Please consult a doctor or professional before using it.

1. People with severely sensitive skin and those in the period of allergy
2. Those with implants on their face
3. Those with large areas of facial trauma
4. Patients with skin diseases and infectious diseases
5. Those who have recently undergone injection products, such as hyaluronic acid, water light, anti-wrinkle, or plastic surgery

## 4.Technical Specification

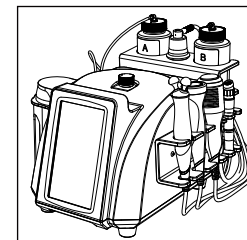

Power supply Input:AC110V-240V 50HZ-60Hz	Net Weight: 5.3KG
Power: 95W	Gross Weight: 6.5KG
Dimensions: 40*36*50CM	
Input Power: 95W	

## 5.Packing List

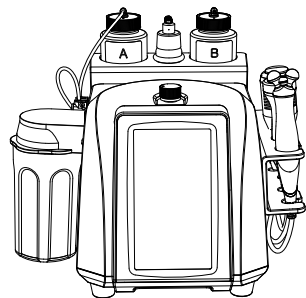

Main unit x 1

Skin energy  
handle x 1

Cold&amp;Hot x 1

Serum boost  
handle x 1

Spray x 1

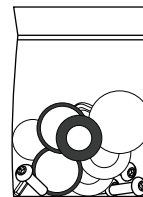

Accessory package x 1



Fuse x 4



Power cord x 1

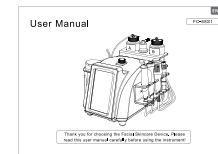

Instruction manual x 1



Microdermabrasion tube x 1

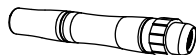

Hydro handle x 1

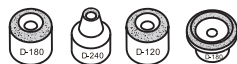

Microdermabrasion head x 4

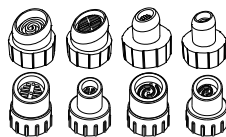

Hydro tips x 8

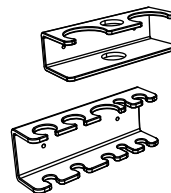

Accessory stand x 2

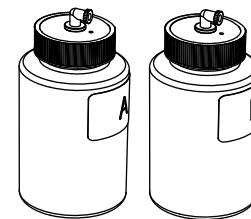

Water purification bottles x 2



Wastewater bottles x 1



Black silicone tube x 1

1m Small Bore Silicone  
Tubing x 11.8m Large Bore  
Silicone Tubing x 1

Note: ⚠

Before use, please check the instrument and accessories or attachments to ensure they are complete. Then remove all packaging materials.

## 6. Installation

1. Install all the accessory racks

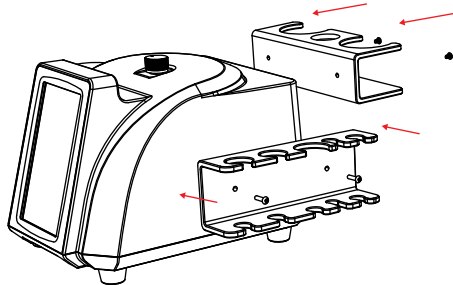

2. Install the connection line for Skin energy handle

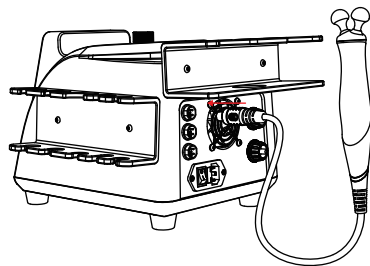

3. Install the connection line for Serum boost handle

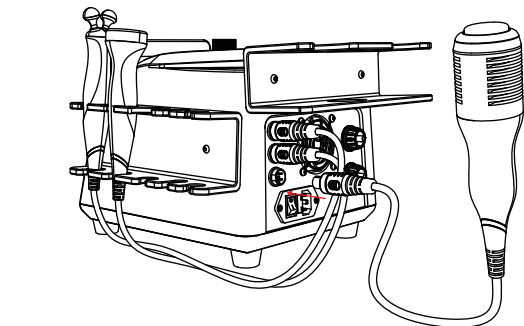
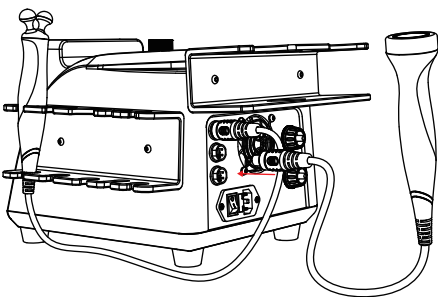

5. Install the connection tube for Microdermabrasion. First connect the white tube to the main unit, then connect it to the Microdermabrasion device

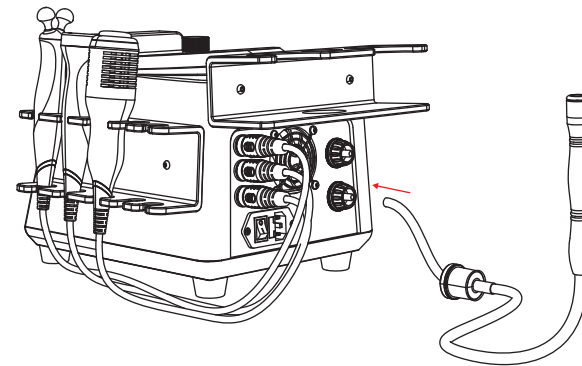

6. Connect the Hydro System Tubing: connect the BLUE tube to the DRAIN (Tip: To remove, press the white collar on the DRAIN fitting and pull the tubing out); connect the WHITE tube to the RIGHT side of the peristaltic pump; connect the DARK tube from Solution bottle to the LEFT side of the pump.

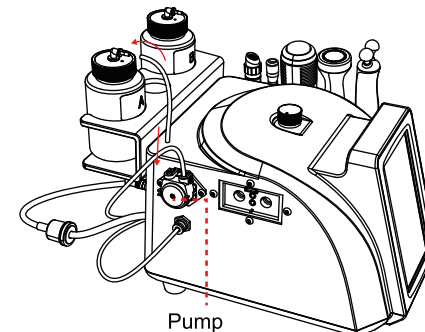
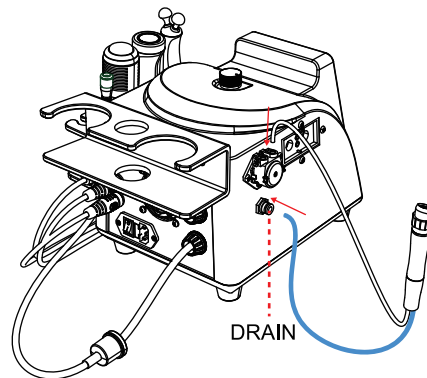

## Replacement of the transparent rubber tube on the peristaltic pump:

1. Press the left and right retaining clips of the peristaltic pump and remove the pump body from the main unit.



2. Press down on the upper and lower clasps of the pump body to open the pump housing.

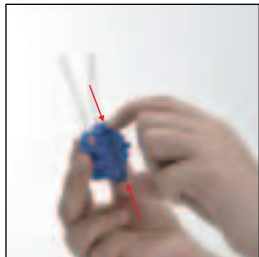

3. Remove the original transparent rubber tube.



4. Insert the new transparent hose into the slot of the pump body.

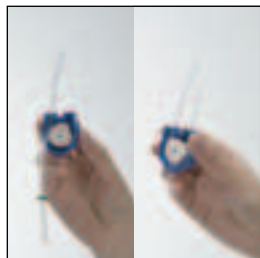

5. Secure the pump body housing and ensure that the snap fastener is properly engaged.



6. Insert the assembled pump body back into the main unit and make sure the connection is secure.



7. Install the connection tube for Spray. First connect the black tube to the main unit, then connect it to the Spray

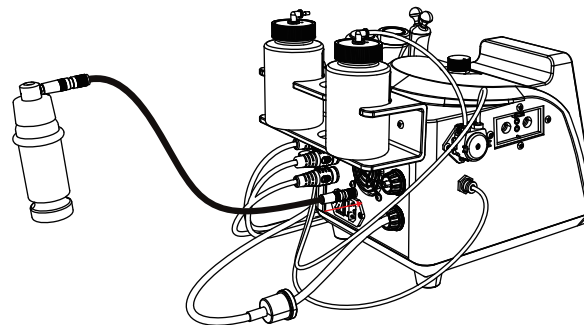

8. Install the waste water bottle

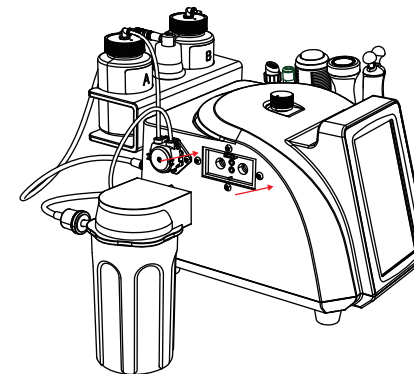

9. Place all the handles and solution bottles on the stand.

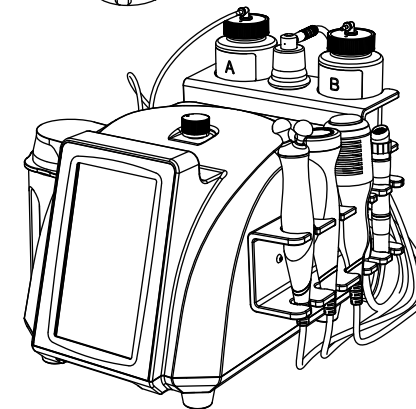

Boot loading page



Main Interface Display

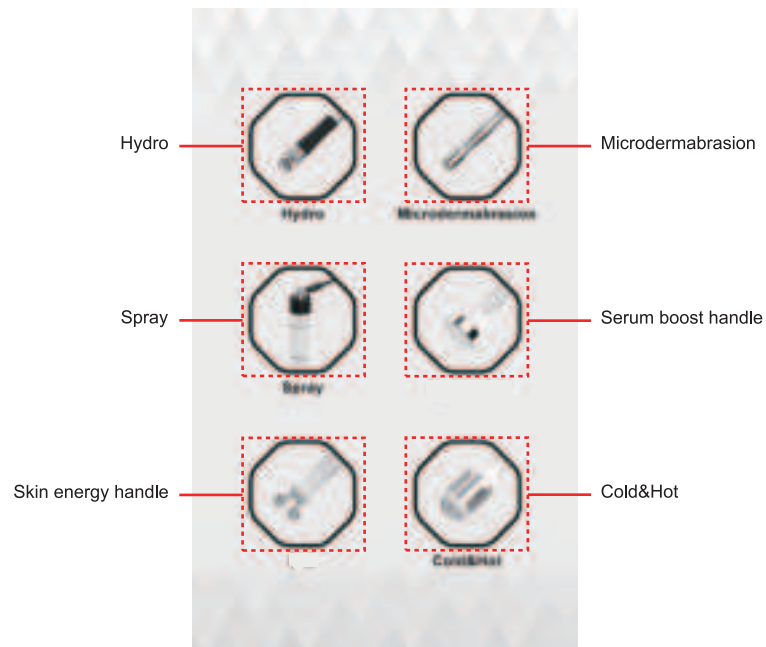

## 7. User Guide

### 1. Hydro

1.1 From the main menu, select the "Hydro" icon to enter the function interface.

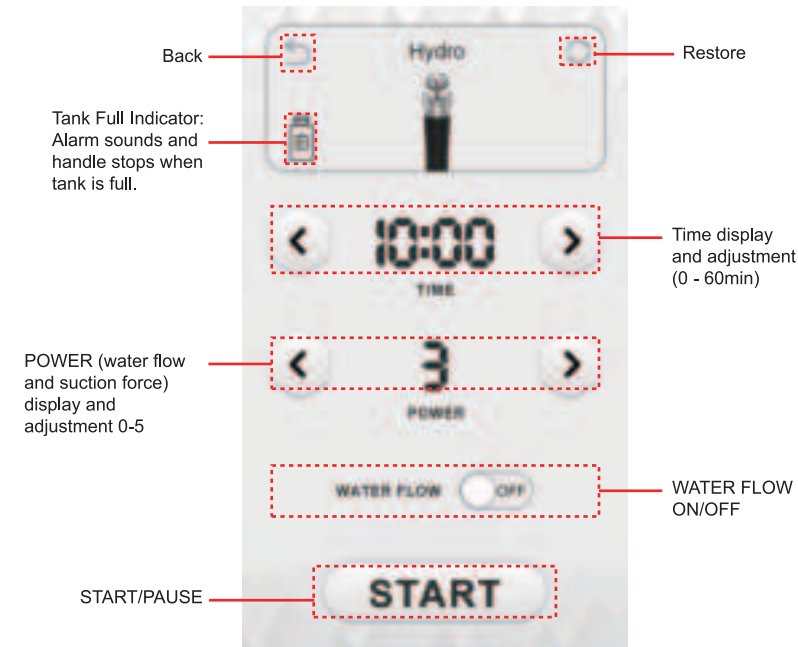
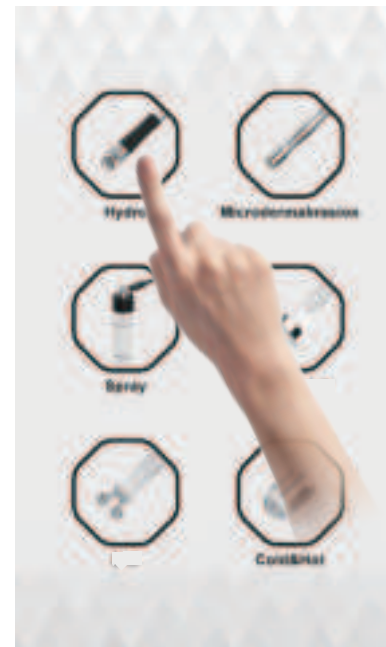

## 1.2 How to Choose a Water Grinder

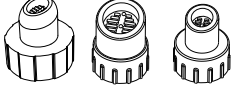
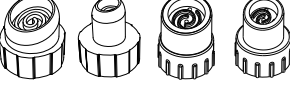
	<p>Flat suction tip: Suitable for cleaning large areas of grease, dust and keratin.</p>
	<p>Straight suction tip: Suitable for cleaning dirt and makeup residue from linear areas of the face (such as the bridge of the nose, philtrum, and around the eyes).</p>
	<p>Spiral suction tip: Suitable for deep cleaning, effectively removing and extracting stubborn dirt, blackheads, and dead skin cells from the pore walls.</p>

**Note:** ⚠

If your skin is sensitive or you prefer a gentle cleansing method, it is recommended to choose the white soft silicone head. The transparent hard silicone head is suitable for normal skin.

## 1.3 Hydro Installation

① Slide the rubber ring onto the handle. (Your unit comes with the ring pre-installed.)



② Choose the desired water grinder and attach it to the handle.



③ Take out solution bottle A and B.

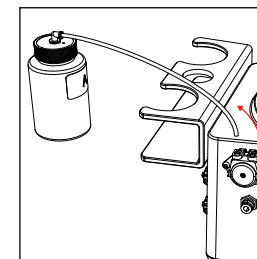

④ Fill bottles A and B with the small-bubble solution or pure water.

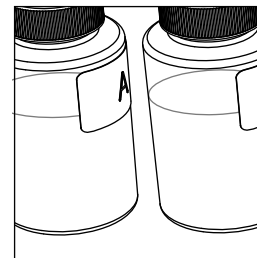

⑤ Place both bottles on the stand.

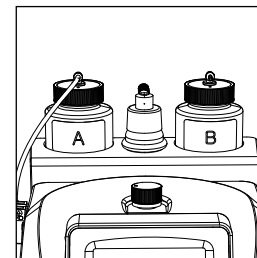

⑥ Connect the clear tube: one end to the top of your chosen solution bottle (A or B), and the other end to the left inlet of the pump.

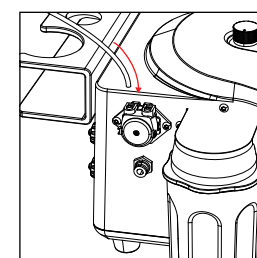

## 1.4 Guidelines for Use

Recommended medium: Small bubble solution (AS1/AO3/SA2) + Blackhead Extraction Solution

### Solution Guide:

AS1: Contains lactic acid, yeast extract, green tea extract, etc. Suitable for normal skin, recommended for full-face use to help deep cleanse and revitalize the skin.

SA2: Contains salicylic acid, lactic acid, sodium lactate, aloe vera and green tea extract, etc. Specially designed for sensitive skin and oily skin. Mainly used on the T-zone to control oil, clean pores and improve skin problems.

- ① Choose the appropriate facial exfoliator based on personal needs and skin condition
- ② Configure Setting: Please configure the device parameters based on your skin's specific needs.
- ③ Start from the chin, perform two to three operations, connect the three points into a line for one operation.

After completing the face treatment, use a circular motion to focus on cleaning the nose area.

Tip: during the process, gently wipe the skin with a damp cotton pad to remove residues as you go.

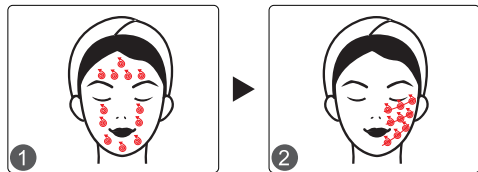

- ④ Recommended Frequency:  
Oily Skin: Once per week  
Combination Skin: Once every 2 weeks  
Normal/Dry Skin: Once every 3 to 4 weeks

## 1.5 Important Notes for Use ⚠

When using, it is recommended to start with the lowest suction force. Once the skin has adapted, gradually increase the suction force to avoid discomfort caused by excessive pulling of the skin.

## 1.6 Cleaning & Maintenance

### Cleaning the Hydro Tip:

① Brush: Clean the interior of the tip with membrane brush or a soft toothbrush to remove any residue.

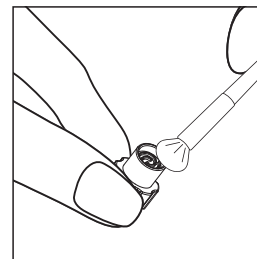

② Soak: Disinfect the tip by soaking it in physiological saline or 70% isopropyl alcohol for 5 minutes.

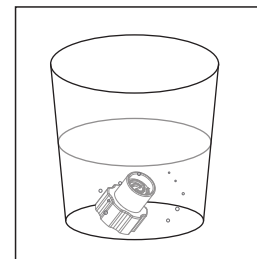

③ Rinse & Store: Rinse thoroughly under running water, pat dry completely with a clean, lint-free cloth, and store it in a clean, dry place.

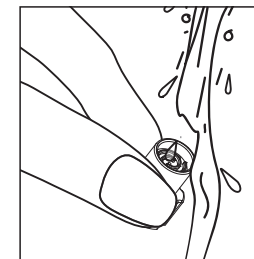

### Flushing the Handle & Tube:

① Prepare: Fill a solution bottle about one-third full with pure or distilled water and attach it to the device.



② Flush: Start the device and briefly place your finger over the opening of the Hydro Tip to create a seal. Continue until the water in the bottle is fully drawn through the system to flush the internal tubing.

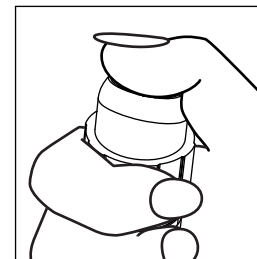

③ Dry: After flushing, run the device for a few seconds with the tip detached to expel any remaining water droplets. Wipe the handle dry.

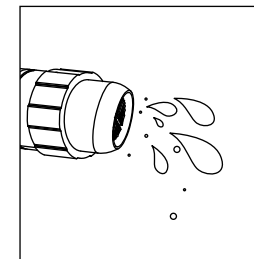





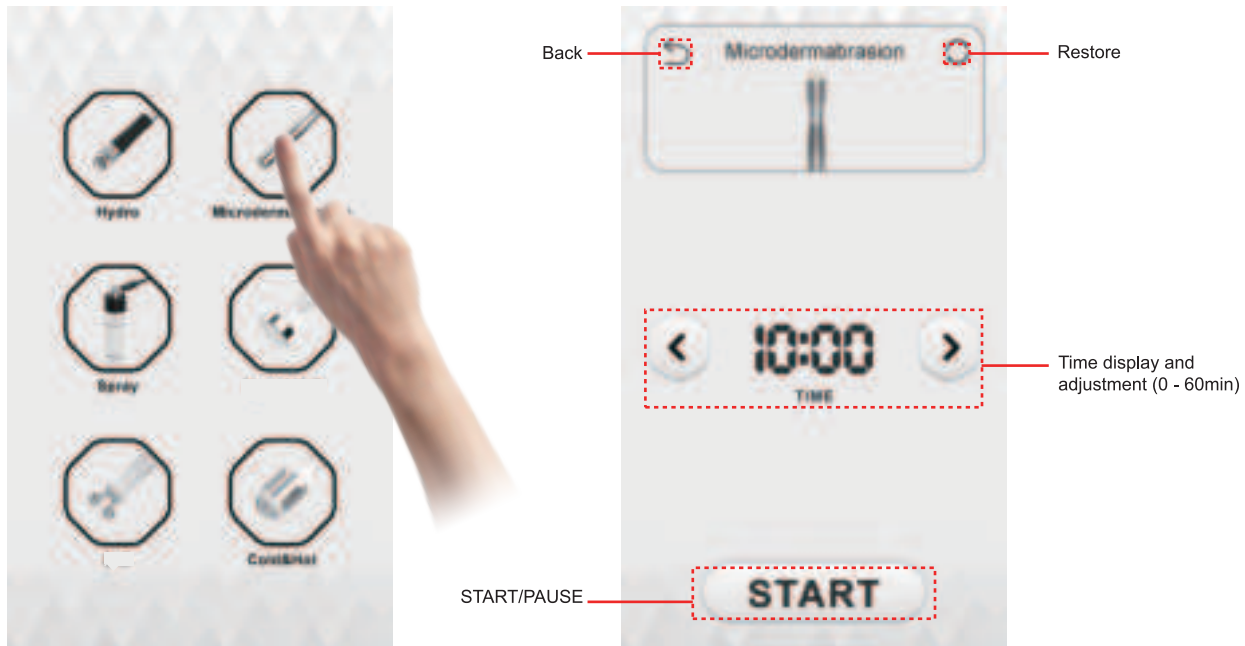



## 2. Microdermabrasion

2.1 From the main menu, select the "Microdermabrasion" icon to enter the function interface.



### 2.2 How to Choose Microdermabrasion

D-180 	For large facial areas.	
D-240 	For small areas around the eyes or nose.	
D-120 	For facial exfoliation.	
D-180 	For facial T-zone area.	

**Note :** ⚠

Do not use the microdermabrasion tip on the same spot for more than 3 seconds. The higher the D number, the finer the grit. We recommend starting with the highest number.

## 2.3 Microdermabrasion Handle Installation

Follow the steps below to install the microdermabrasion handle. The red arrows in the diagrams highlight key actions and connection points.

① Inspect the rubber ring: check the handle for the pre-installed black rubber ring. If it is missing or damaged, replace it before use.

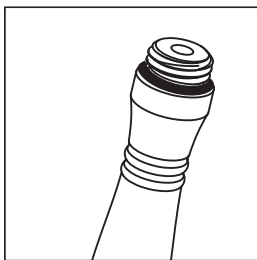

② Place the cotton filter: position a clean cotton filter over the port on the handle.

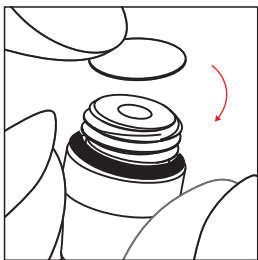

③ Attach the tip: screw your desired tip firmly onto the handle.

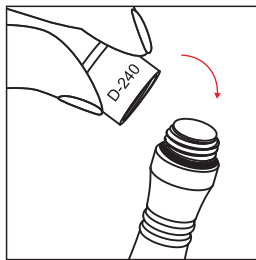

④ Connect suction hose to handle: connect one end of the transparent suction hose to the handle's port.

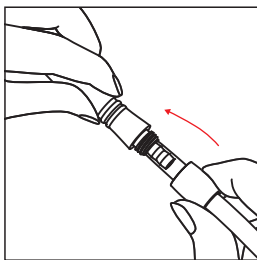

⑤ Connect suction hose to main unit: connect the other end of the hose to the suction port on the main unit.

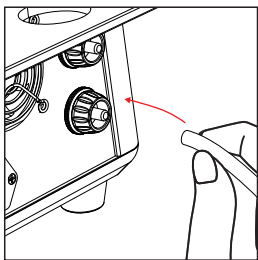

## 2.4 Guidelines for Use

- ① Before you begin: Apply a gentle cleansing lotion or water-based gel to prepare the skin.
- ② Adjustment: Choose a microdermabrasion tip suited to your skin type and concern.

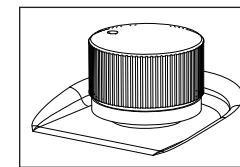
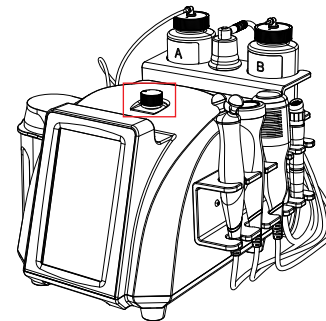

Suction intensity is adjusted via the side knob (see inset). Always start at the lowest level and increase only if comfortable.

- ③ Configure Settings: Please configure the device parameters based on your skin's specific needs.
- ④ Application: starting at the chin, glide the handle steadily upward. Use the same motion on the cheeks and forehead. Apply light circular motions on the nose.  
During Use: you may periodically wipe the skin with a damp cotton pad to clear away exfoliated residue.



- ⑤ Suggested Interval:
- Oily Skin: Once every 2 weeks.
  - Normal / Combination Skin: Once every 3 to 4 weeks.
  - Dry or Sensitive Skin: Once every 4 to 6 weeks.

## 2.5 Safety & Usage Precautions

- ① **Start with Low Suction:** Always begin your session at the lowest suction level. Gradually increase intensity only after your skin has adapted, to prevent discomfort or potential irritation from overly aggressive session.
- ② **Use the Filter Cotton:** The filter cotton must be installed before every use. Operating the device without it may allow extracted debris to enter the internal mechanism, which can cause damage and reduce the product's lifespan.

## 2.6 Cleaning & Maintenance

- ① **After Each Use:** Rinse the tip thoroughly under warm running water. For a deeper clean, wash with a mild, soapy solution.
- ② **Key Reminder:** Always detach the tip from the handle before cleaning.

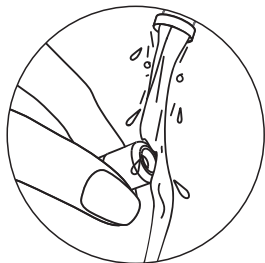

### Note :

- ① Replace the microdermabrasion tip every 3 months to ensure optimal performance and hygiene.
- ② Replace the filter cotton inside the tip after every 3 uses.

## 3. Spray

3.1 From the main menu, select the "Spray" icon to enter the function interface.

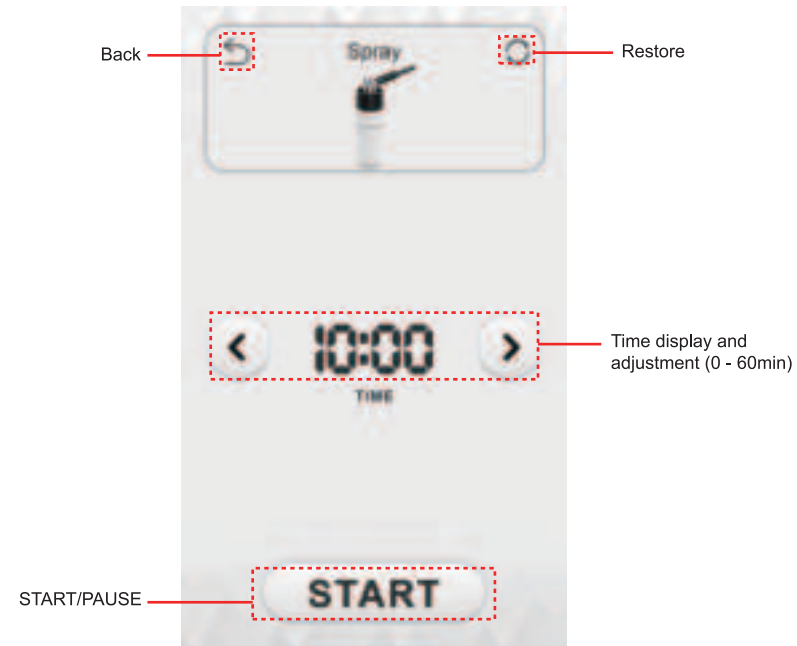
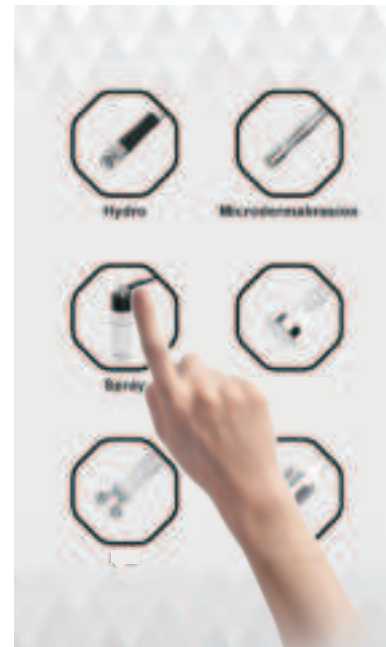

### 3.2 Spray Function Installation

1. Fill the bottle with your chosen liquid , such as water, toner, saline solution etc. Recommended dilution ratio with water: 1:10. Select a solution that is suitable for your skin type.



2. Attach one end of the transparent hose to the outlet port on the main unit.

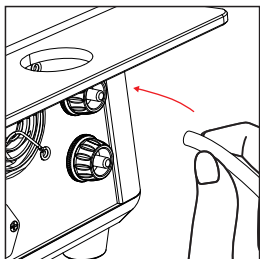

3. Connect the other end to the spray bottle.

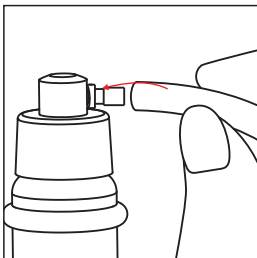

4. To activate the spray, place your finger over the air intake on the spray head to create a seal, then start the device.

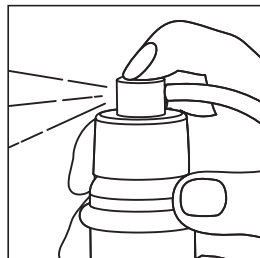

#### Important Note : ⚠

always ensure all connections are secure before operation to prevent leaks.

### 3.3 Guidelines for Use

Follow the steps below for an optimal spray application session.

- ① Configure Settings: Please configure the device parameters based on your skin's specific needs.
- ② Prepare the Solution: Fill the spray bottle with your chosen medium.
- ③ Application Technique: Hold the device 15-20 cm from your face. Apply the spray using gentle, continuous circular motions across the skin, as illustrated.



- ④ Recommended Frequency:  
Normal Skin: 2-3 times per week  
Dry Skin: Once per day  
Oily / Combination Skin: 2-3 times per week

### 3.4 How to Clean the Spray Bottle

1. Fill the bottle about one-third full with clean water.
2. Place your finger over the air inlet on the spray head to create a seal.
3. Start the device and spray until the water is fully expelled to flush the nozzle and tube.

### 3.5 Important Precautions ⚠

Avoid Clogging: Do not use highly concentrated or viscous solutions, as they can clog the spray nozzle. If clogged, should a clog occur, gently clear the nozzle aperture with a needle to restore normal spray function.

## 4. Serum boost handle

### 4.1 From the main menu, select the four icon to enter the function interface.

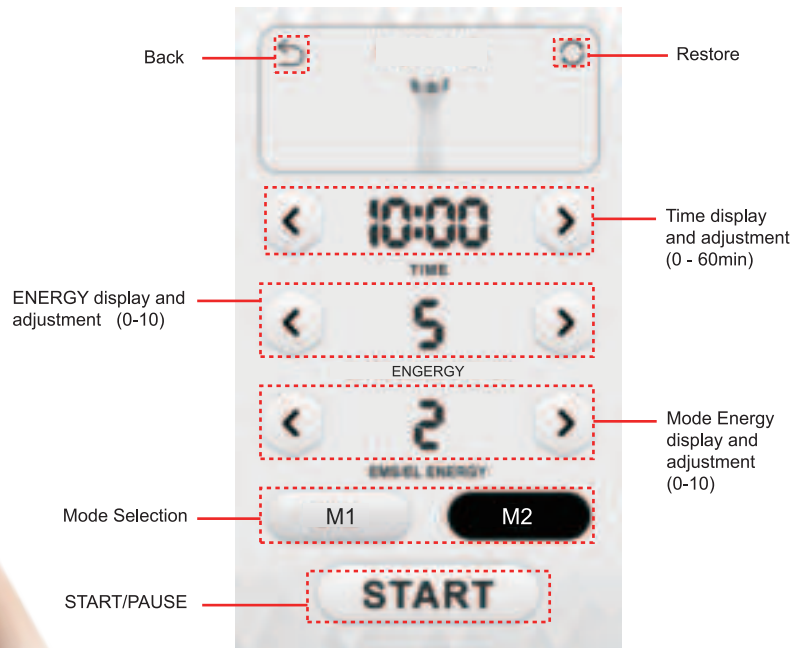

### 4.2 Guidelines for Use

Follow the steps below for optimal application of the Dynamic Pulse function.

- ① Configure Your Session: Please configure the device parameters based on your skin's specific needs.
- ② Apply Coupling Medium: Use a sufficient amount of conductive gel or serum on the treatment area. This ensures smooth gliding of the device and promotes effective product infusion.
- ③ Recommended Method: Gently move the device handle across your face using continuous circular motions or upward lifting strokes, as demonstrated in the diagrams. Ensure consistent contact with the skin.



- ④ Recommended Usage Frequency:  
 Dry Skin: 2-3 times per week  
 Oily Skin: 2 times per week  
 Normal / Combination Skin: 1-2 times per week

### 4.3 Important Precautions

**Keep the Device Moving:** Do not hold the device stationary on one spot for an extended period, as this may cause skin discomfort.

**Start Low, Go Slow:** Always begin at the lowest intensity level. Gradually increase the level only after your skin has acclimated to the sensation.

## 5. Skin energy handle

### 5.1 From the main menu, select the five icon to enter the function interface.

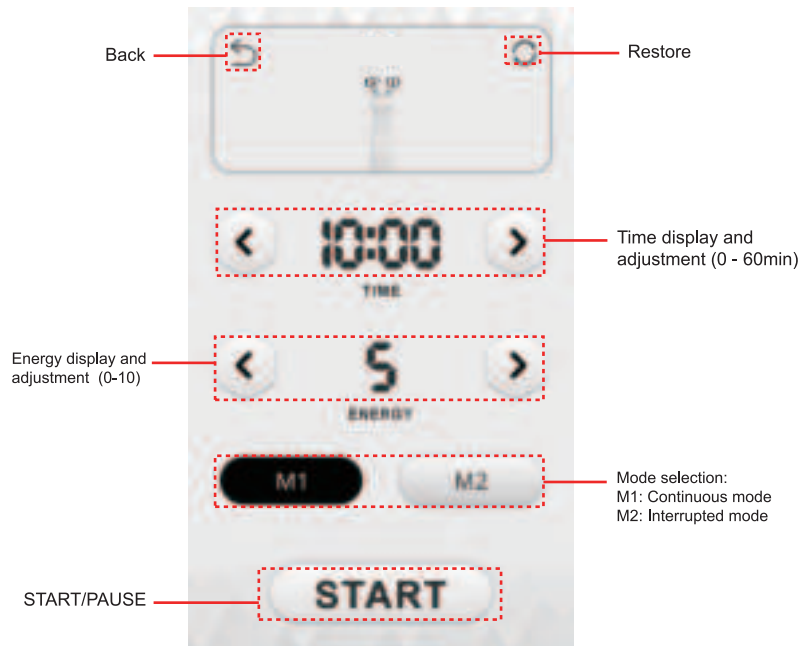
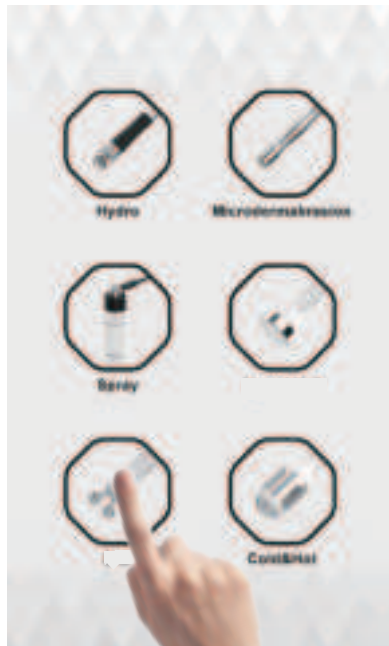

### 5.2 Guidelines for Use

- ① Configure Settings: Please configure the device parameters based on your skin's specific needs.
- ② Recommended Application Medium: Apply a sufficient amount of serum to the skin before and/or during use. This helps the handle glide smoothly and promotes product absorption.
- ③ Recommended Method: Use upward and outward lifting motions on the face, as demonstrated in the illustrations. Pay special attention to delicate areas such as around the eyes.



- ④ Recommended Frequency:  
Dry / Normal Skin: 1-2 times per week  
Oily / Combination Skin: Once per week

### 5.3 Important Precautions

**Keep the Handle Moving:** Avoid holding the device in one spot for an extended period to prevent any skin discomfort.  
**Start Low:** Always begin at the lowest energy level and allow your skin time to adapt before considering a gradual increase in intensity.

## 6. Cold&Hot

6.1 From the main menu, select the “Cold&Hot” icon to enter the function interface.

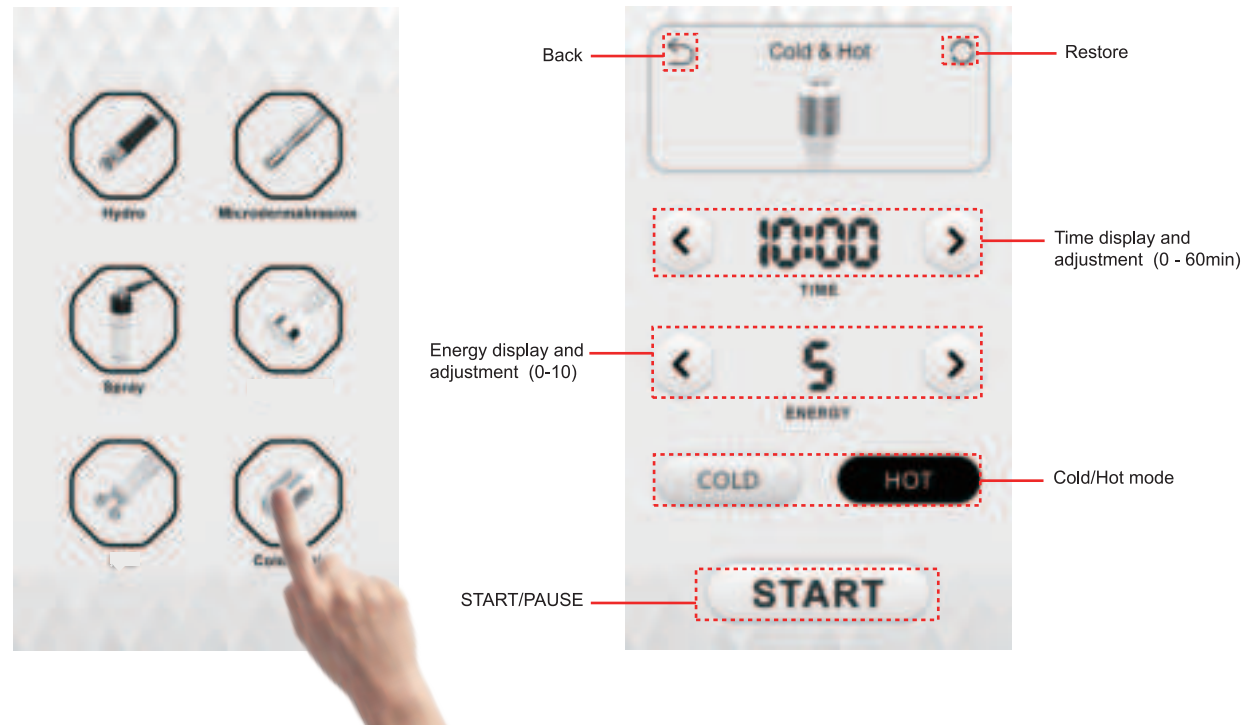

### 6.2 Guidelines for Use

- ① Configure Settings: Please configure the device parameters based on your skin's specific needs.
- ② Recommended Application Medium: Apply a sufficient amount of gel or serum to the skin before use. This enhances glide and improves the experience.
- ③ Recommended Method: Gently move the handle across your face using circular motions or upward lifting strokes, as demonstrated in the illustrations.

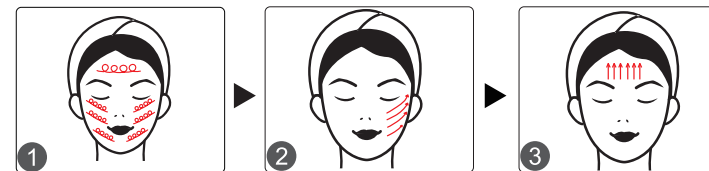

- ④ Recommended Frequency:  
 Dry / Normal Skin: 1-2 times per week  
 Oily / Combination Skin: Once per week

### 6.3 Important Precautions

**Keep the Handle Moving:** Do not hold the device stationary on one area for an extended period to prevent skin discomfort.  
**Avoid Blocking Vents:** Ensure the device's air outlet remains unobstructed during use to maintain proper temperature and prevent overheating.

## 8. Troubleshooting Guide

**This section provides solutions to common operational issues. Please follow the steps below before contacting support.**

### 8.1 No Suction in Microdermabrasion Function

Possible Causes & Solutions:

- **Hose Connection:** Ensure the transparent hose is correctly connected to the suction port on the main unit and is securely attached to the handle.
- **Rubber Ring:** Check that the rubber ring on the handle is present and intact. If it is missing or damaged, replace the rubber ring.
- **Hose Integrity:** Inspect the entire length of the PVC hose for cracks or damage. If any are found, replace the PVC hose.

### 8.2 Spray Function Not Dispensing Liquid

Possible Causes & Solutions:

- **Liquid Concentration:** The liquid in the bottle may be too concentrated, causing a clog in the nozzle. Use only recommended, non-viscous solutions (e.g., diluted essence or saline).
- **Air Inlet Blocked:** During use, do not cover the air inlet on the spray head with your finger, as this prevents the creation of suction and stops the liquid flow.

### 8.3 No Suction or Water Flow in Hydro Function

Possible Causes & Solutions:

- **Interface Setting:** Confirm that the Hydro function is selected and activated on the device interface.
- **Loose Connection:** Check and reconnect all tubing associated with the Hydro handle to ensure connections are tight and secure.

### 8.4 Need More Help?

If the problem persists after trying the solutions above, please contact our Customer Support team for further assistance.

## 9. FAQ

### Q1: Why does my face turn red after use? Is this normal?

A: Yes, this is a common and temporary reaction. The device works on a vacuum principle. When the handle makes contact, it causes a brief increase in blood flow (capillary congestion) in the area, which may lead to temporary redness. This typically fades within a few hours. We recommend applying a moisturizer immediately after your session to soothe and hydrate the skin.

### Q2: Which skin types is this device suitable for?

A: The device is designed for all major skin types: normal, dry, oily, and combination. **Important Note for Sensitive Skin:** If you have sensitive skin, we advise consulting a dermatologist or skincare professional before first use to ensure it's appropriate for you.

### Q3: Will my skin become thinner or more sensitive with regular use?

A: No. The process is designed to cleanse pores by removing impurities like blackheads and whiteheads. It does not thin the skin's protective barrier. With consistent and correct use, the goal is to promote smoother, clearer-looking skin and should not induce sensitivity.

### Q4: Why do I feel a tingling sensation during use?

A: A mild tingling or prickling sensation is a normal response for some users, often associated with the suction effect and enhanced product absorption. It should not be painful. If you feel significant discomfort, please stop immediately and use a lower intensity setting.

### Q5: How soon can I expect to see results?

A: Results can vary based on your individual skin and consistency of use.

- **After First Use:** Many users notice their skin feels immediately cleaner, softer, and smoother.
- **Visible Improvements:** With regular use over 8 to 12 weeks, you may observe a reduction in the appearance of fine lines, wrinkles, dark spots, and uneven skin tone.

## 10. Warranty and support

A one-year warranty will be provided starting from the date of your purchase.

If you have any questions during use or if there are any problems with the product. We can also provide you with more skincare guidance.

You can scan the QR code below to watch the video on the installation and operation of the instrument.

Product Name: Facial Skincare Device

Product Model: FC-68S1

Production Date: \_\_\_\_\_

Quality Inspection: \_\_\_\_\_

